

OASYS  
HEALTHCARE

OASYS  
HEALTHCARE

# OASYS CENTRAL AXIS

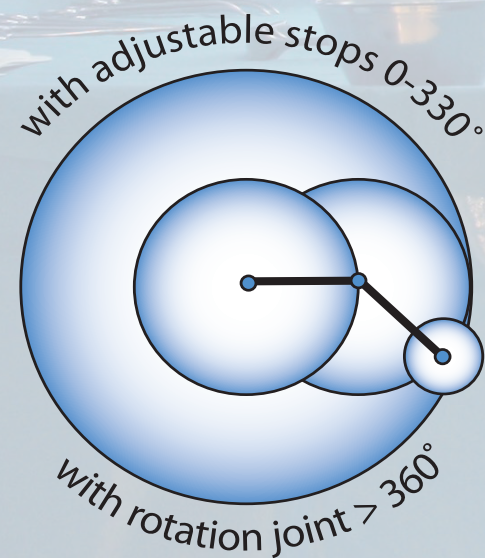

OASYS  
HEALTHCARE

[sales@oasyshealthcare.com](mailto:sales@oasyshealthcare.com)  
[www.oasyshealthcare.com](http://www.oasyshealthcare.com)

Tel: 905.852.3399  
Toll-Free: 1.877.996.2797  
Fax: 905.852.3323

ISO 9001: 2015  
3011034B Rev: B



OASYS  
HEALTHCARE

# Custom Spring Arms

# OASYS CENTRAL AXIS Multiple Spring Arm Suspension System

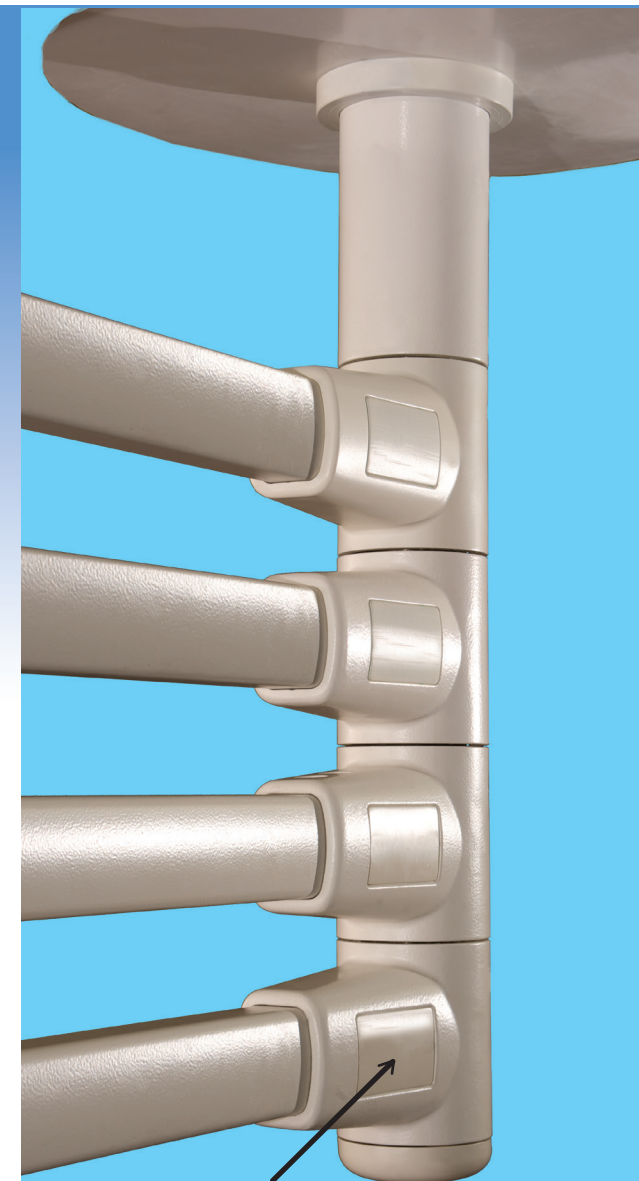
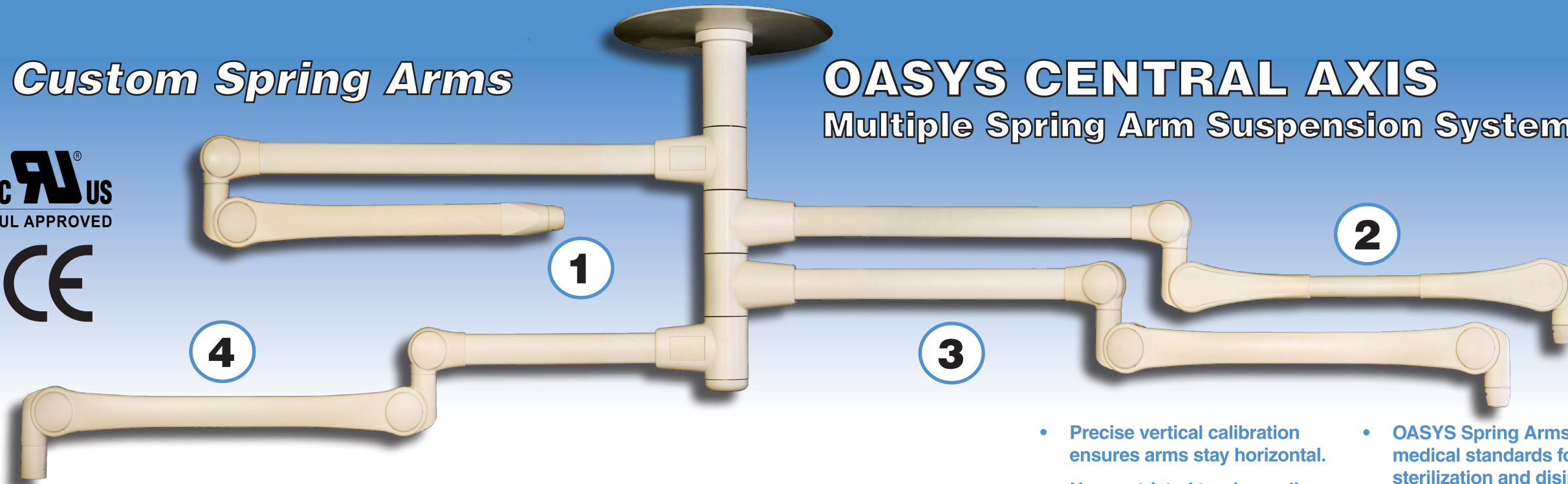

Cable panels provide quick and easy access.

- Precise vertical calibration ensures arms stay horizontal.
- Non restricted turning radius on all arms.
- Custom load options.
- Modular construction for easy installation.
- Each arm can have a slip ring with full rotation or a stop.
- User set vertical elevation angle.
- Hassle free spring arm accessibility through easily removable covers.
- OASYS Spring Arms exceed all medical standards for cleaning, sterilization and disinfection.
- All OASYS Spring Arms are available with adjustable load, height adjustable range and locatable stops for your convenience.
- Specially designed with cable management in mind, allowing for quick and easy wiring and re-wiring in the field.
- Customized OEM solutions available, contact us for a quote.

## OASYS LCH Spring Arm

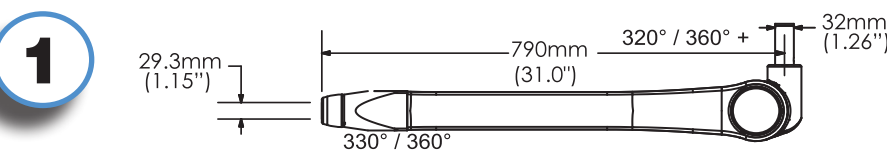

**Arm Length:** 790mm (31.0")  
**Load Ranges:** 45 - 265 Nm, (33 - 195 lb.ft)  
**Features:** Low ceiling applications.

**Maximum Cable Allowance:** 465mm<sup>2</sup> (0.72 in<sup>2</sup>)  
**Maximum Single Cable Diameter:** 19mm (0.75")

## OASYS 77 Spring Arm

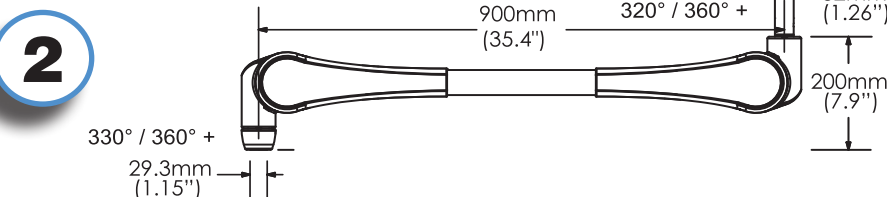

**Arm Length:** 900mm (35.4")  
**Load Ranges:** 4.5 - 21 kg, (10 - 46 lbs)  
**Features:** Available to use with multiple applications.

**Maximum Cable Allowance:** 130mm<sup>2</sup> (0.20 in<sup>2</sup>)  
**Maximum Single Cable Diameter:** 13mm (0.5")

## OASYS 2001 Spring Arm

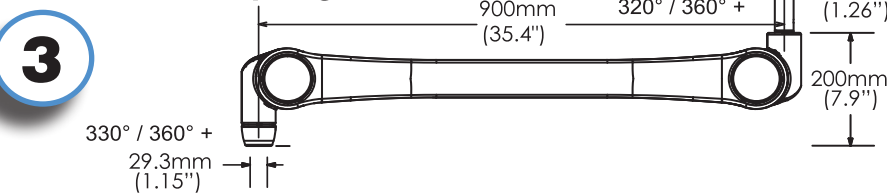

**Arm Length:** 900mm (35.4")  
**Load Ranges:** 4.5 - 21 kg, (10 - 46 lbs)  
**Features:** Increased cable management, removable covers.

**Maximum Cable Allowance:** 465mm<sup>2</sup> (0.72 in<sup>2</sup>)  
**Maximum Single Cable Diameter:** 19mm (0.75")

## OASYS 3001A Spring Arm

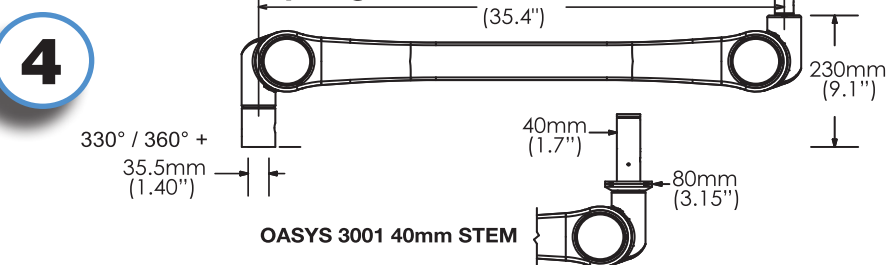

**Arm Length:** 900mm (35.4")  
**Load Ranges:** 4.5 - 30 kg, (10 - 66 lbs)  
**Features:** Versatile connection types, removable covers.

**Maximum Cable Allowance:** 465mm<sup>2</sup> (0.72 in<sup>2</sup>)  
**Maximum Single Cable Diameter:** 19mm (0.75")

## Overall Specifications

**Rotation:** Four position adjustable 320° stops, or >360° with optional slip ring

**Safety Factor:** Four times the rated payload towards the yield strength as per IEC 60601

**Approvals:** UL, CUL, CE

**Electrical:** 100-240V, 12 A, slip ring available to enable full rotation

**Classification:** IEC 60601-1, UL 60601-1, CAN/CSA-C22.2 No. 601.1-M90

**Color:** RAL 9010, RAL 7035, RAL 9002, Custom colours available upon request

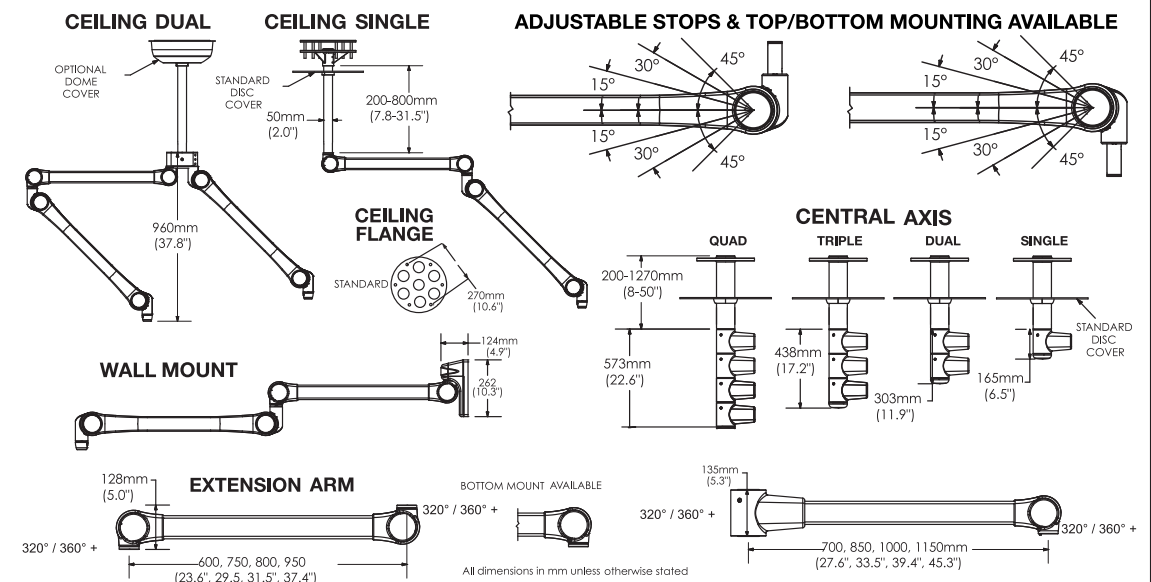

Committed to Quality. Committed to You.

Customized Options